

# 電動氣彈槍

FULL SEMIAUTO

# CM.030

請仔細閱讀說明書

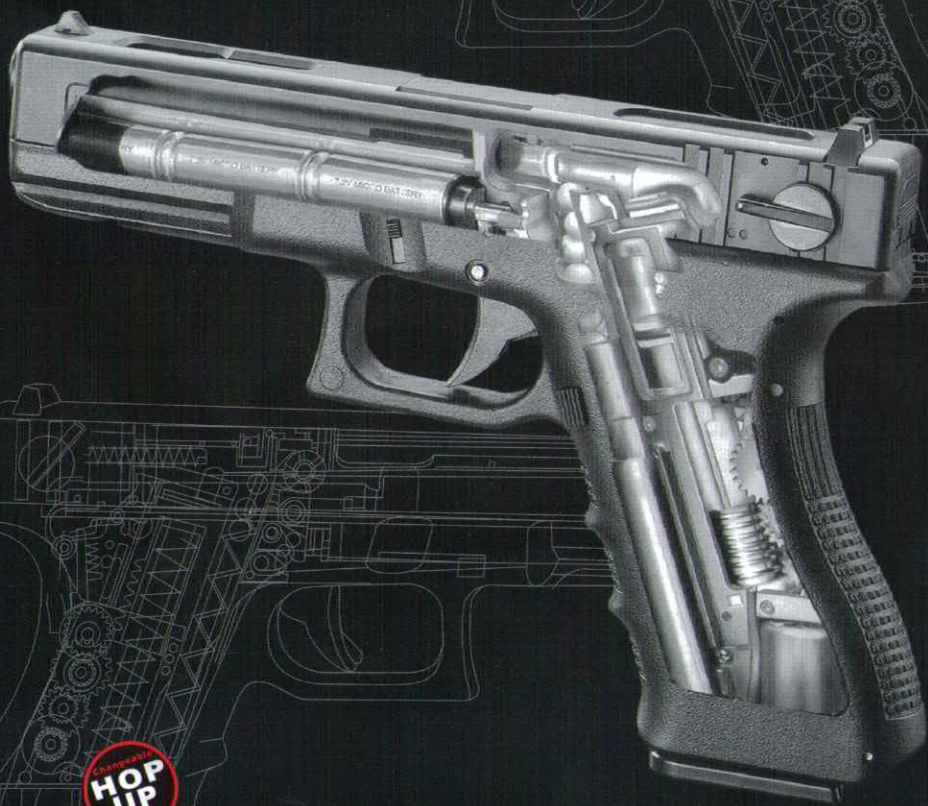

在操作之前必需读熟这些说明书

Always read through this manual before operation.



## 警告 WARNING



18岁以上年龄才能使用  
Only for 18 years  
of age or older

18岁以上年龄才能利用这支汽枪比赛使用  
Operation of this air gun for competition use is restricted to users of 18 years of age or older.



注意受损伤  
Injury caution

因为BB弹能达到50-60米范围, 不小心的射击可能导致眼睛受损伤或其它伤害。  
Since plastic BB bullets reach 50 to 60 meters, careless shooting may cause eye damage or other injuries.



注意熟读警告指示手册  
Careful reading of  
Handling cautions  
and  
instruction manual

在操作之前要细心读熟警告手册和指示手册操作汽枪时必须认识好警告指示  
Always read through this HANDLING CAUTION AND INSTRUCTION MANUAL carefully before operation.  
Operate the air gun with full recognition of warnings and cautions.

## FOR AGES: 18 AND UP

# 电池与充电器 ACCUMULATOR AND CHARGER

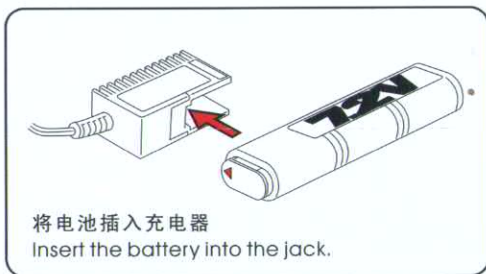
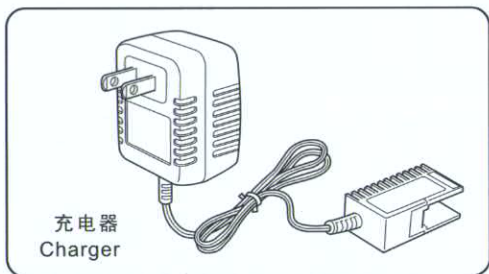

## 1 各部分名称 NAME OF EACH PART

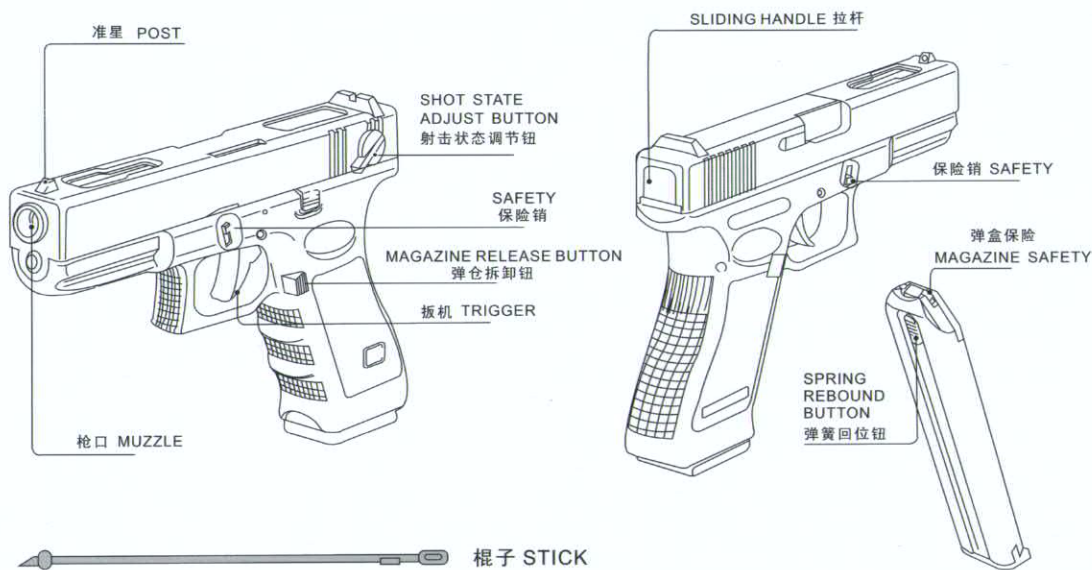

## 2 保险销 SAFETY





### 3 充电池 ACCUMULATOR

- ① Press the button at the end of the handle to disassemble the handle.  
用拇指压住拉杆尾端的按钮卸下拉杆。

Handle release button  
拉杆拆卸钮

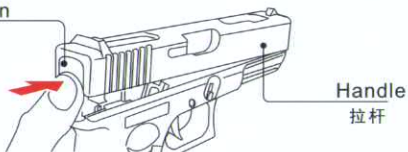

- ② Insert the battery into gun.  
将充电池插入枪身。

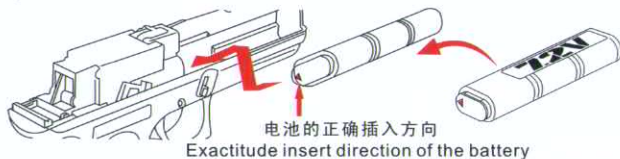

- ③ Aim at the adjust hole, cover the handle till a click sound heard.  
对准校正孔, 将拉杆盖上。

校正孔  
Adjust hole

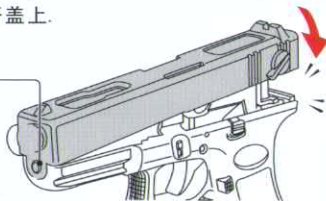

### 4 单发\连发 SINGLE \ RUNNING SHOOT

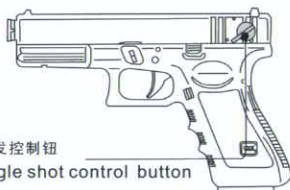

单发\连发控制钮  
Running/single shot control button



Never put finger on the trigger  
when adjust the button  
调节按钮时请勿将手指放在扳机上

Single shoot position < ● >

单发位置



Single shoot: the button point upward,  
one bullet shoot out one time.

单发: 将按钮拨向单发位置, 射击时每次只发一弹

running shoot position < ● ● >

连发位置



a running shoot: the button point downward,  
more bullets shoot out one time.

连发: 将按钮拨向连发位置, 射击时可连续发射多弹

# 5 安装\拆卸弹仓 INSTALL \ DISASSEMBLE THE MAGAZINE

1 PRESS THE MAGAZINE RELEASE BUTTON TO RELEASE THE MAGAZINE.  
按住弹仓拆卸按钮拆卸弹仓。

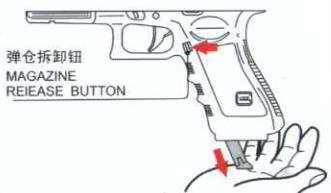

2 LOAD 6MM BB BULLETS INTO THE MAGAZINE.  
装入6MM bb弹。

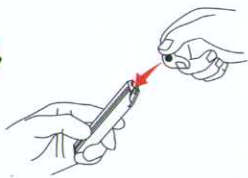

3 PUSH THE MAGAZINE INTO THE GUN TILL A CLICK SOUND HEARD.  
将弹仓推入枪身直至听到“喀嚓”一声。

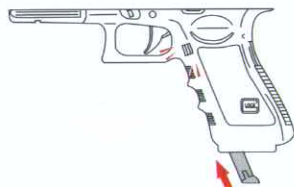

● Adjust the parabola regulate button to adjust the direction of the parabola.

通过调节抛物线调节钮  
调节抛物线的方向

THE PARABOLA  
REGULATE BUTTON  
抛物线调节钮

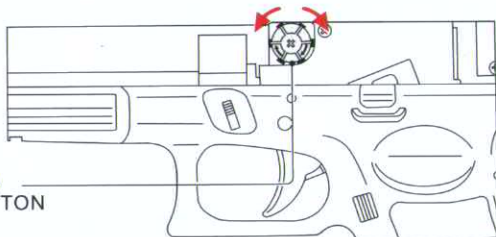

● The best position is where the bullets fly horizontally, and the longest range is obtained.

保持水平方向的射击能够使BB弹获得最远射程。

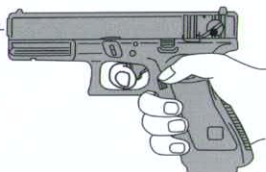

## 警告·注意

● Our company will not be responsible for trouble caused by using the bullet produced by other company.

我公司不对使用其它公司BB弹产品而引起事故负责。

● The bunglesome bb bullet is damage with the gun. Please use the precision bb bullet of our company.

拙劣的BB弹会对枪支造成严重损害，请使用我公司的标准BB弹系列产品。

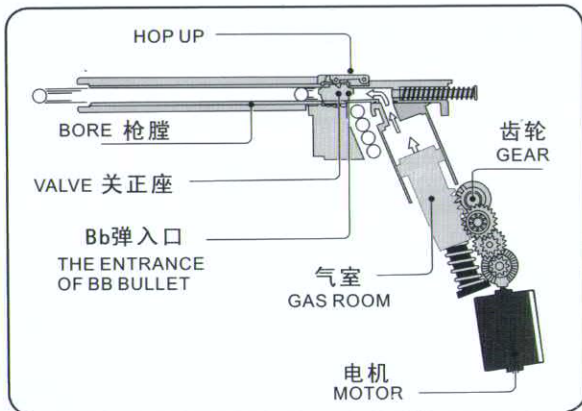
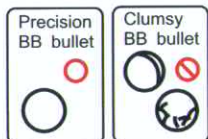

## 6 射击 SHOT

### ① DIAL THE POINTER TO THE RUNNING/SINGLE SHOT POSITION

将指针拨到连发/单发位置。



SINGLE SHOT

RINNING SHOT

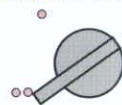
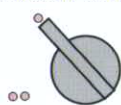

### ② PUSH THE SAFETY TO THE TOP.

将安全销推到上端。

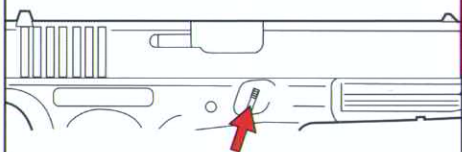

### ③ PULL THE TRIGGER TO SHOT.

扣动扳机射击。

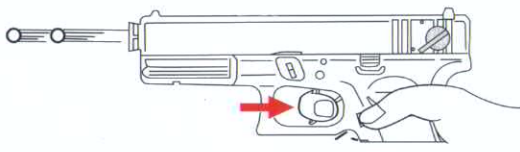

## 7 清除阻塞BB弹 REMOVE CLOGGED BULLETS

### 1 清通枪膛 CLEAN THE BORE

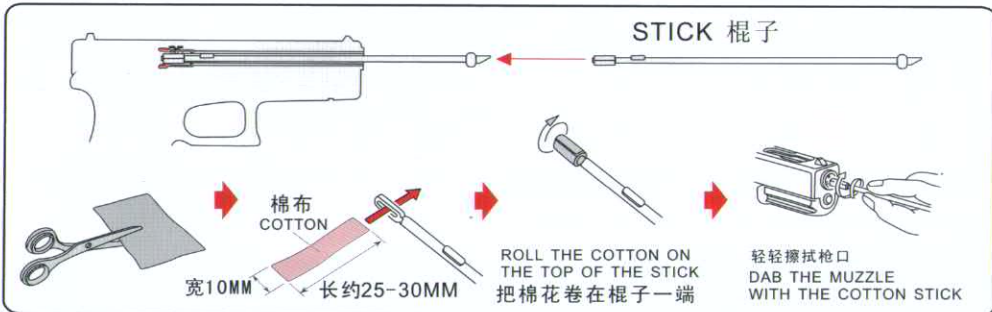

### 2 清除阻塞BB弹 REMOVE CLOGGED BULLETS

#### ① INSERT THE STICK INTO THE MUZZLE.

将棍子插入枪口。

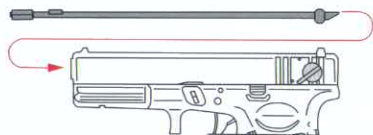

#### ② REMOVE THE CLOGGED BULLETS.

清除阻塞的BB弹。



### 3 取出BB弹 TAKE OUT CLOGGED BULLETS

OPEN THE COVER, TAKE OUT THE CLOGGED BULLETS.

打开枪把底部的盖子，取出BB弹。

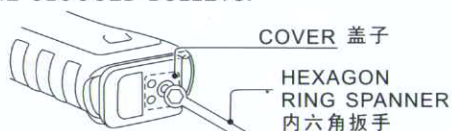



# ● THE COMPOSITION OF CM.030

